

Piattaforma Autosollevante Mast Climbing Work Platform

EP 2818

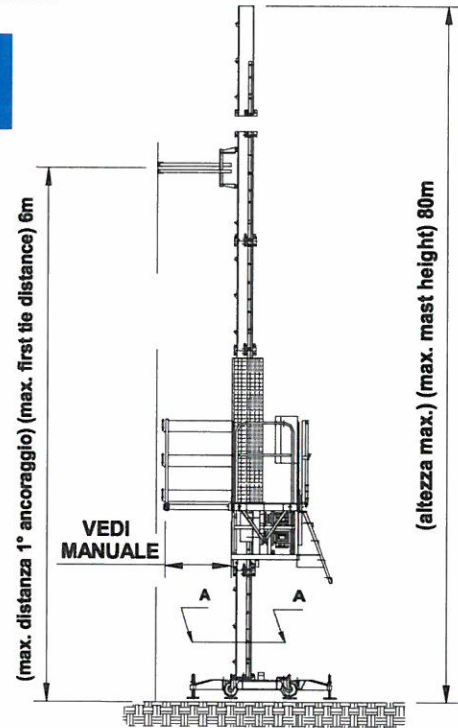

EP 2818/7 MONOCOLONNA - SINGLE MAST

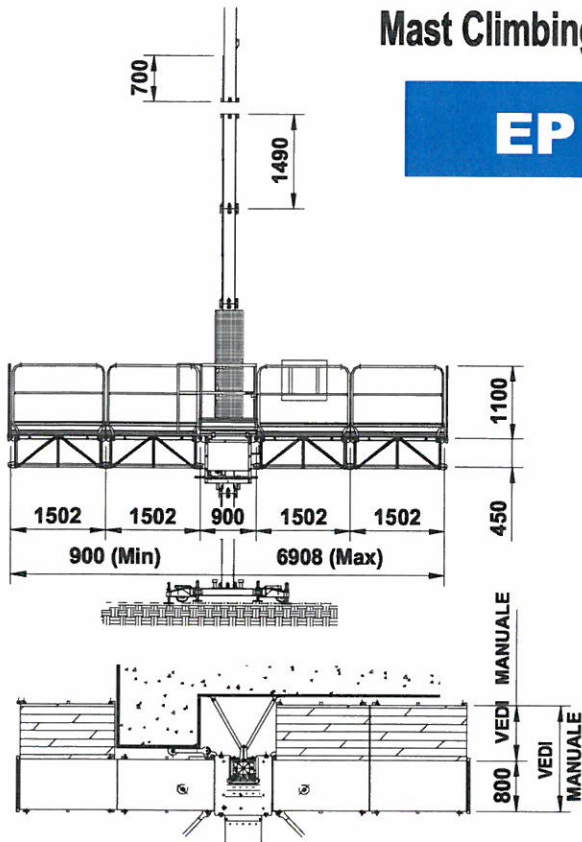
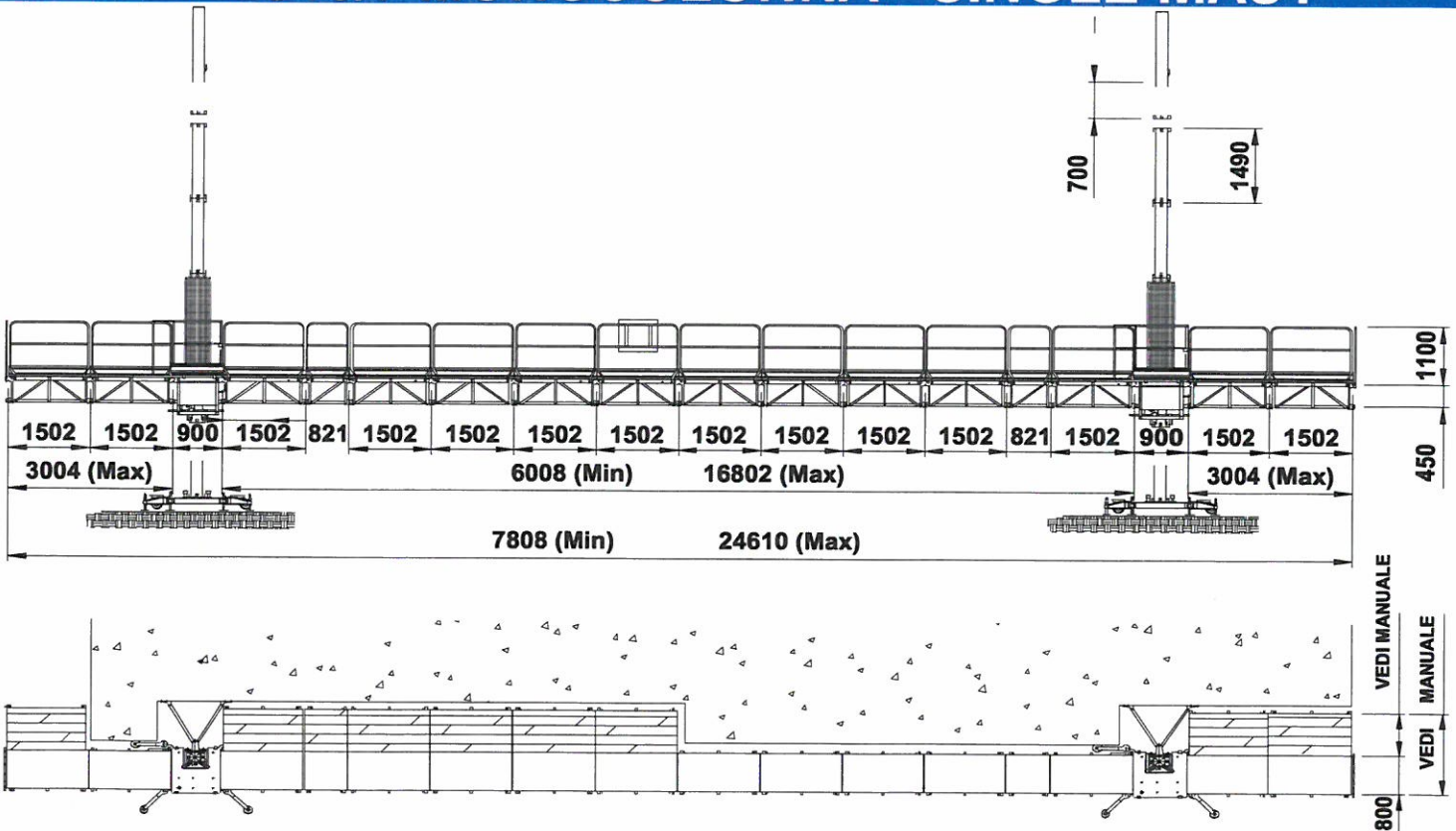

EP 2818/25 BICOLONNA - TWIN MAST

EP 2818

Dati Tecnici	Technical Data	Données Techniques	Datos Tecnicos	EP 2818/7	EP 2818/25
Massima capacità di carico	Max. Capacity	Max charge	Max capacidad de carga	1250 kg	2600 kg
Velocità di sollevamento	Lifting speed	Vitesse de levage	Velocidad de elevación	10,6 m/min	10,6 m/min
Max lunghezza piattaforma	Max platform length	Max longueur plate-forme	Longitud max plataforma	6,9 m	24,6 m
Larghezza piattaforma	Platform width	Largeur plate-forme	Ancho plataforma	0,8 m	0,8 m
Lunghezza Standard estensioni telesc.	Standard telesc. extension	Long. standard des extensions	Longitud standard extensiones	0,8 m	0,8 m
Max. Lunghezza estensioni telesc.	Max extension length	Max longueur extensions	Longitud max extensiones	2 m* max	2 m* max
Massima altezza libera	Max freestanding height	Hauteur max sans ancrages	Altura max autoestable	6 m	6 m
Max altezza ancorata	Max anchored height	Max hauteur avec ancrages	Altura max con anclajes	80 m	80 m
Intervallo ancoraggi	Max tie distance	Intervalle ancrages	Distancia entre anclajes	7,5 m max	7,5 m max
Tensione alimentazione	Input power range	Tension d'alimentation	Tensión de red	380/50 Hz 415/60 Hz	380/50 Hz 415/60 Hz
Potenza servizio continuo	Power of the motors	Puissance des moteurs	Potencia de motorreductores	2 X 1,5 kW	4 X 1,5 kW
Minima potenza di linea consigliata	Minimum line power required (suggested)	Min. puissance de ligne conseillée	Min. potencia linea	6 kW	10 kW

* Contattare Electroelsa
* Contact Electroelsa

Dimensioni base
Base frame dimensions

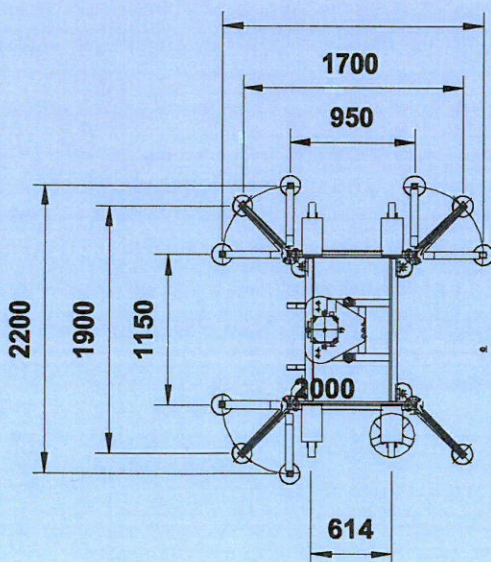

Peso proprio macchina su ciascun basamento
Dead load on each base frame

H	EP 2818/7	EP 2818/25
12 m	1400 kg	1700 kg
24 m	1870 kg	2070 kg
36 m	2150 kg	2350 kg
48 m	2520 kg	2730 kg
60 m	2900 kg	3100 kg
72 m	3280 kg	3480 kg

N.B. Ai pesi sopra elencati aggiungere il 50% del carico trasportato
Add the 50% of the transported load to the above mentioned weights

EP2818

Dettagli colonna verticale
Mast section details

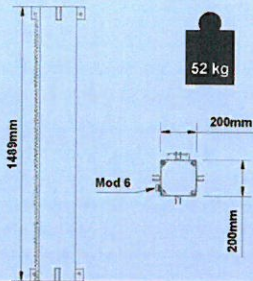

Dettagli moduli ponte
Deck module details

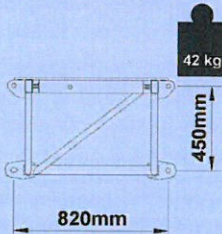
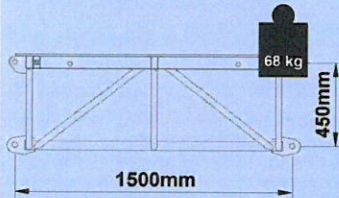

Vista frontale modulo ponte
Deck Module Front View

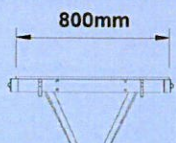

Estensioni a parete
Telescopic Wall Extensions

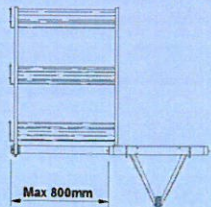

Stabilizzatori rimovibili
Removable outriggers

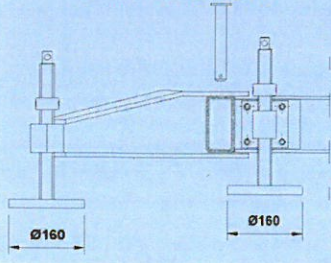

Dettagli gruppo di sollevamento
Drive unit details

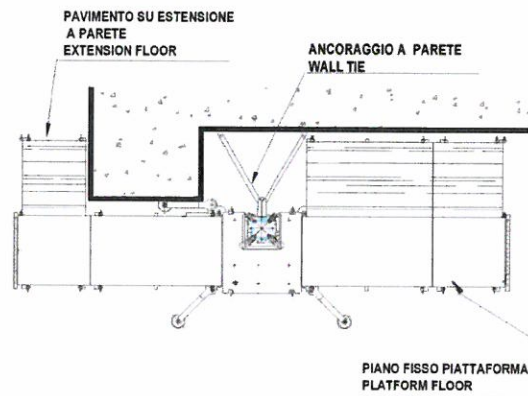
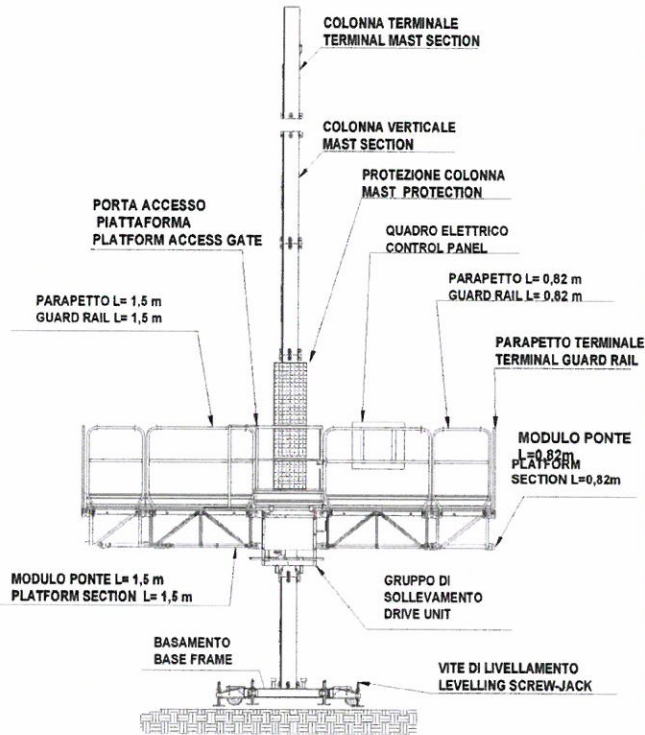
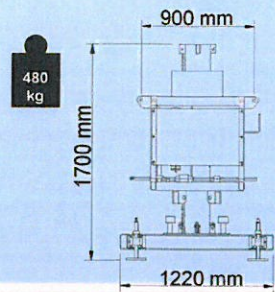

Altezza libera oltre ultimo ancoraggio
Overhang condition Max 6 m

Intervallo ancoraggi
Mast tie interval Min/Max 37,5 m

massima distanza 1° ancoraggio
max first tie distance 6 m

altezza massima colonna ancorata / max anchored height 80 m

Ruote pivotanti rimovibili
Removable pivoting wheels

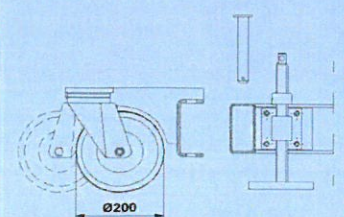

EP 2818

**CARICHI MASSIMI
MAX LOADS**

