

Piattaforma Autosollevante Mast Climbing Work Platform

EP 3125

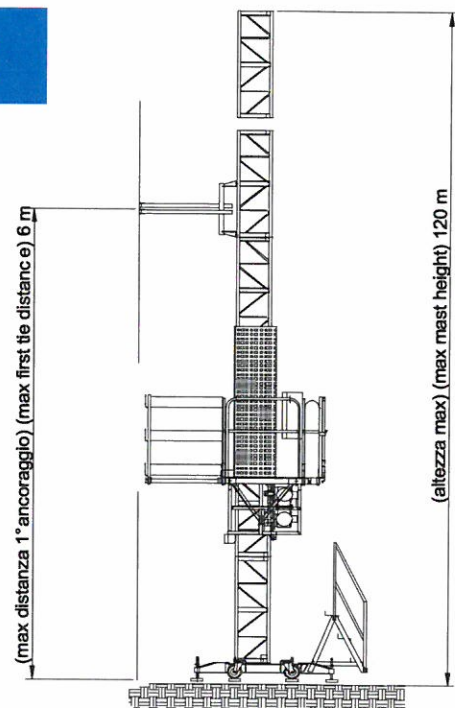

EP 3125/9 MONOCOLONNA - SINGLE MAST

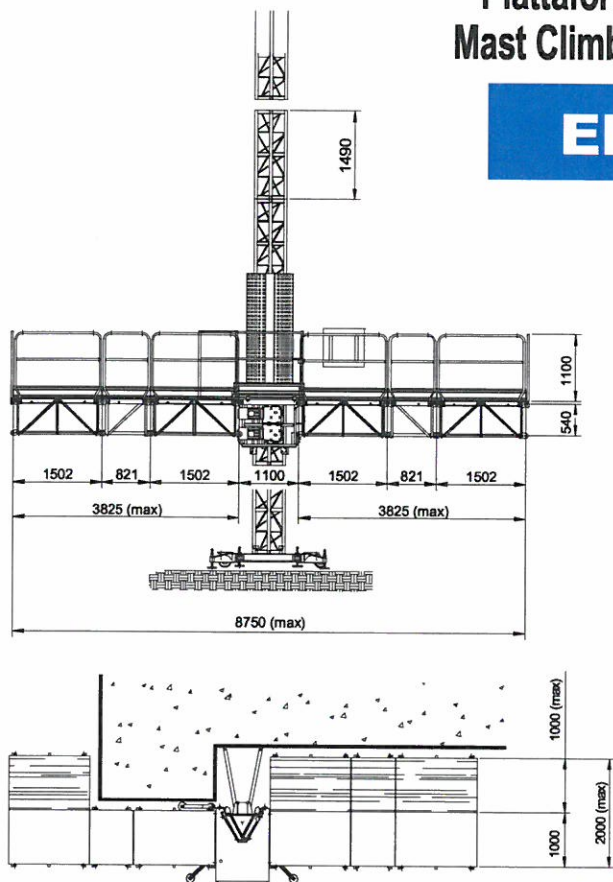
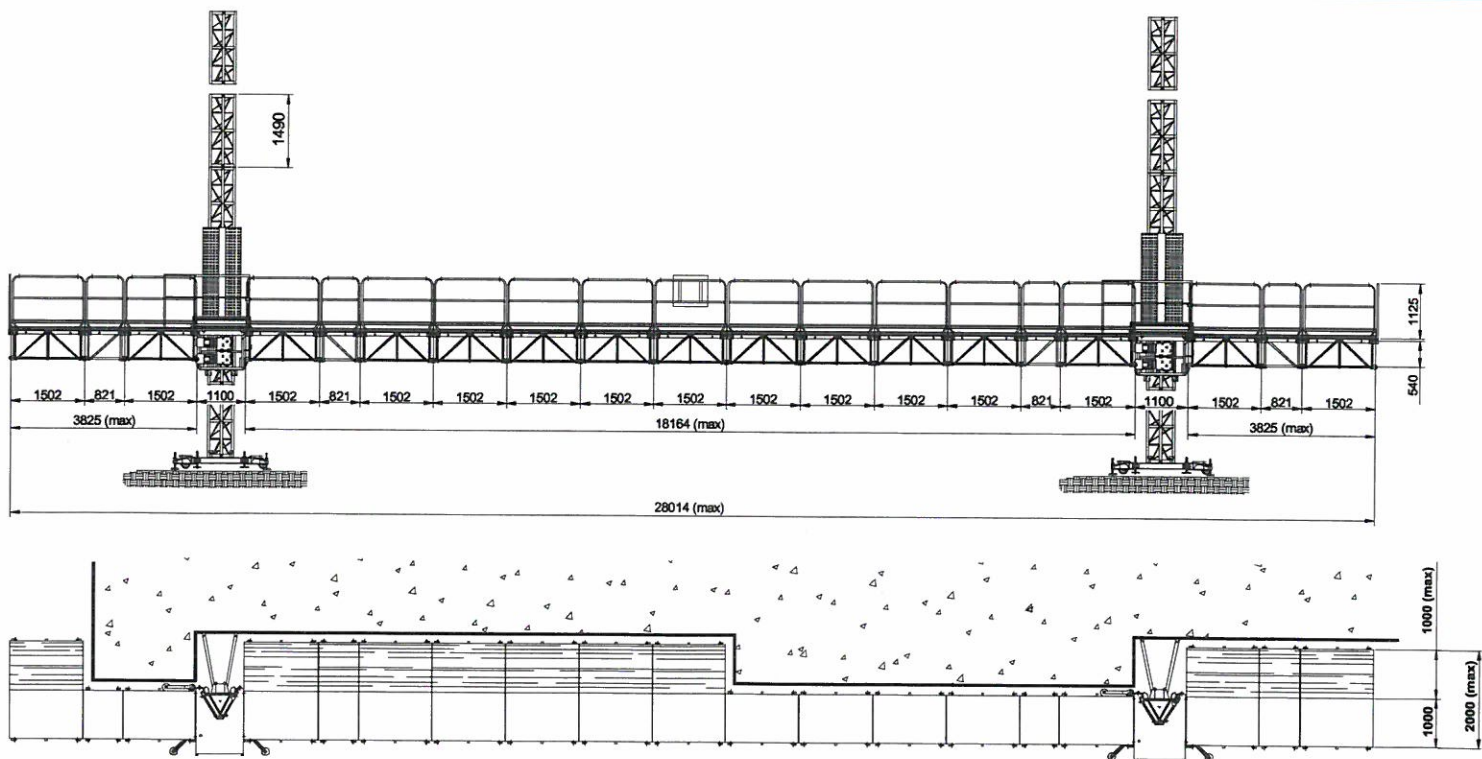

EP 3125/28 BICOLONNA - TWIN MAST

EP 3125

Dati Tecnici	Technical Data	Données Techniques	Datos Tecnicos	EP3125/9	EP3125/28
Massima capacità di carico	Max. Capacity	Max charge	Max capacidad de carga	1650 kg	3500 kg
Velocità di sollevamento	Lifting speed	Vitesse de lévage	Velocidad de elevación	10,6 m/min	10,6 m/min
Max lunghezza piattaforma	Max platform length	Max longueur plate-forme	Longitud max plataforma	8,75 m	28 m
Larghezza piattaforma	Platform width	Largeur plate-forme	Ancho plataforma	1 m	1 m
Lunghezza Standard estensioni telesc.	Standard telesc. extension	Long. standard des extensions	Longitud standard extensiones	1 m	1 m
Max. Lunghezza estensioni telesc.	Max extension length	Max longueur extensions	Longitud max extensiones	2,5 m* max	2,5 m* max
Massima altezza libera	Max freestanding height	Hauteur max sans ancrages	Altura max autoestable	6 m	6 m
Max altezza ancorata	Max anchored height	Max hauteur avec ancrages	Altura max con anclajes	120 m	120 m
Intervallo ancoraggi	Max tie distance	Intervalle ancrages	Distancia entre anclajes	6 m	6 m
Tensione alimentazione	Input power range	Tension d'alimentation	Tensión de red	380/50 Hz 415/60 Hz	380/50 Hz 415/60 Hz
Potenza servizio continuo	Power of the motors	Puissance des moteurs	Potencia de motorreductores	2 X 2,2 kW	4 X 2,2 kW
Minima potenza di linea consigliata	Minimum line power required (suggested)	Min. puissance de ligne conseillée	Min. potencia linea	6 kW	10 kW

* Contattare Electroelsa
* Contact Electroelsa

Dimensioni base
Base frame dimensions

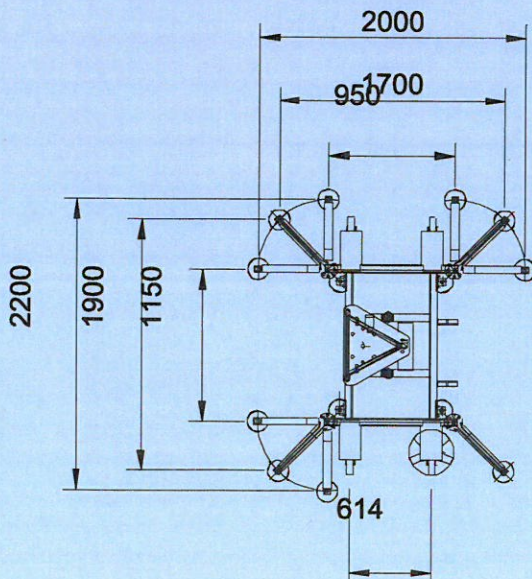

Peso proprio macchina su ciascun basamento
Dead load on each base frame

H	EP 3125/9	EP 3125/28
12 m	2100 kg	2440 kg
24 m	2400 kg	2780 kg
36 m	2780 kg	3110 kg
48 m	3110 kg	3450 kg
60 m	3450 kg	3790 kg
72 m	3790 kg	4120 kg

N.B. Ai pesi sopra elencati aggiungere il 50% del carico trasportato
Add the 50% of the transported load to the above mentioned weights

EP 3125

**CARICHI MASSIMI
MAX LOADS**

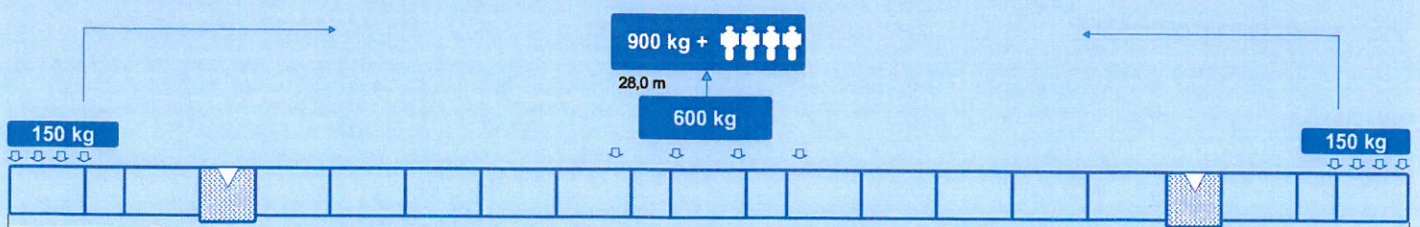
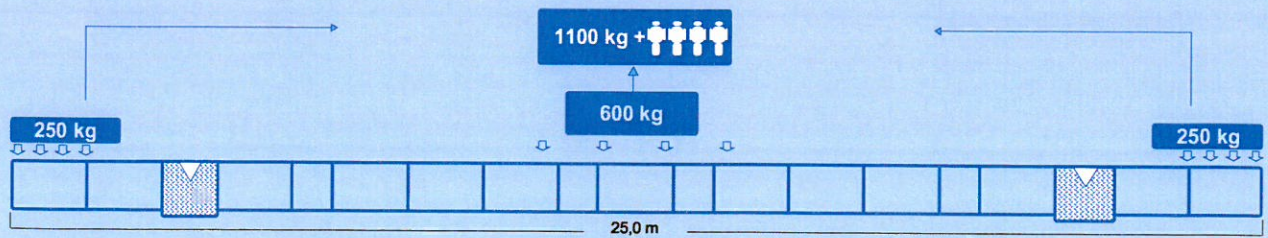
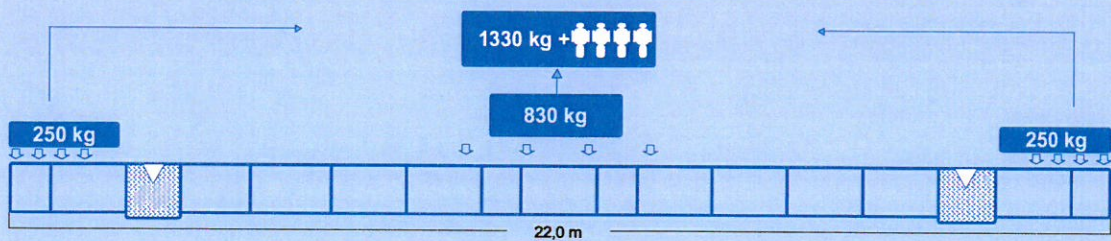
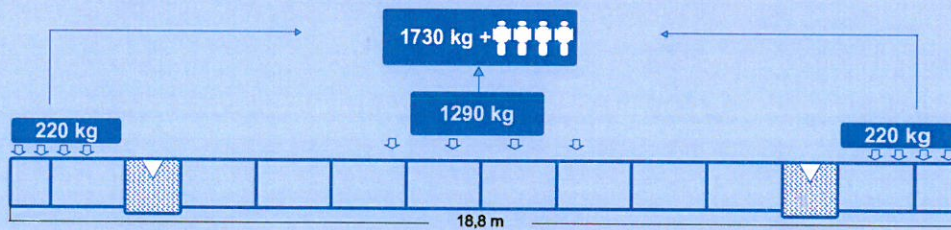
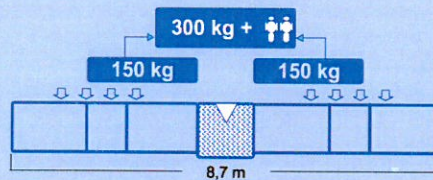
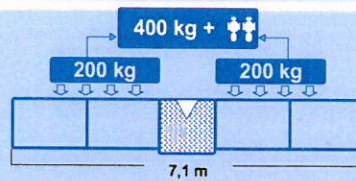
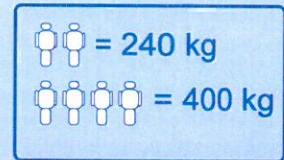
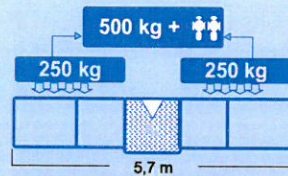

EP 3125

Dettagli colonna verticale Mast section details

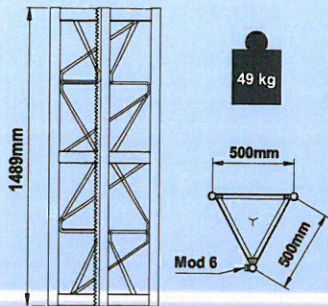

Dettagli moduli ponte Deck module details

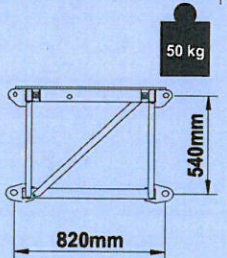
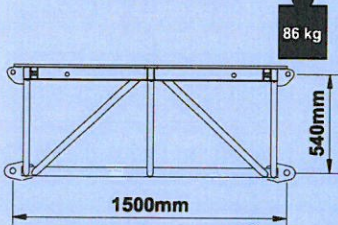

Vista frontale moduli ponte Deck Module Front View

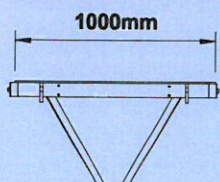

Estensioni a parete Telescopic Wall Extensions

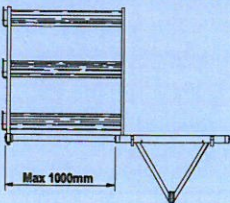

Stabilizzatori rimovibili Removable outriggers

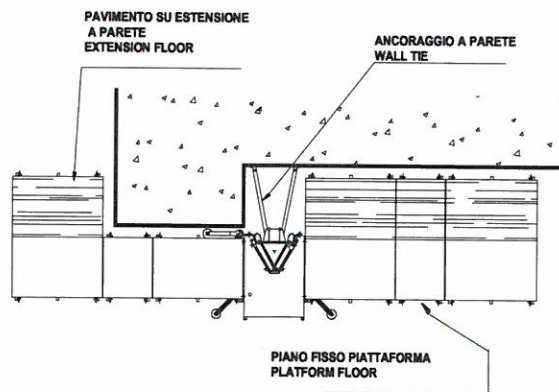
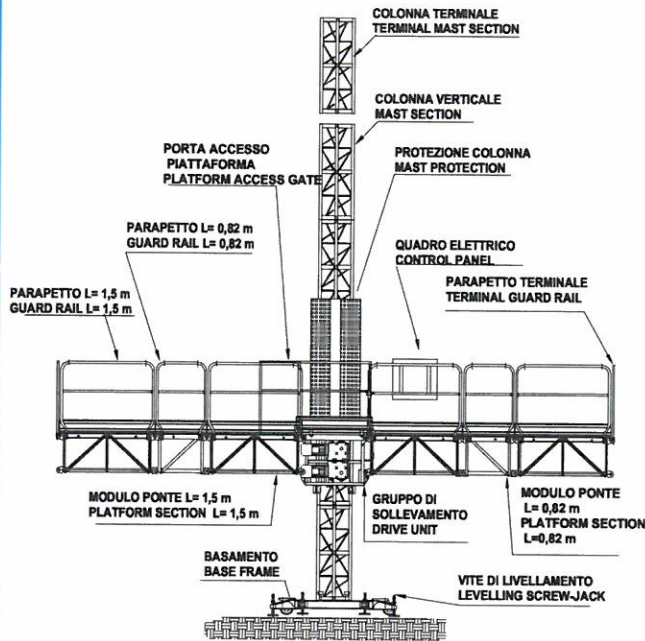
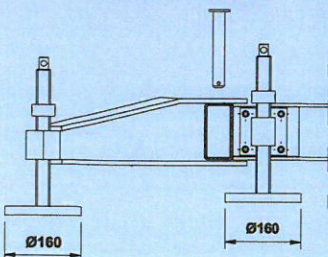

Dettagli gruppo di sollevamento Drive unit details

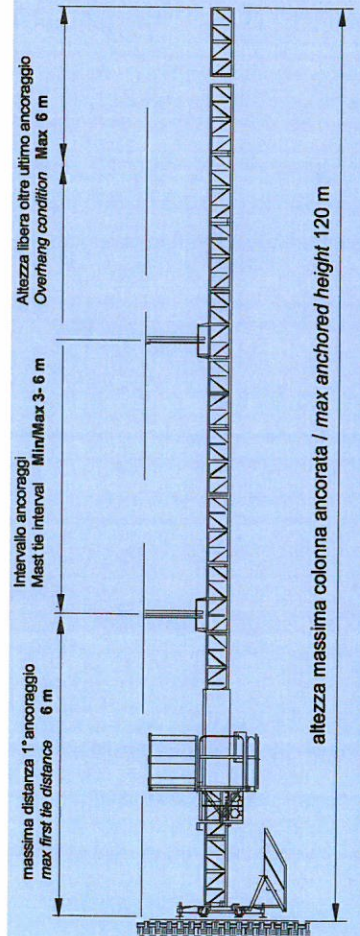
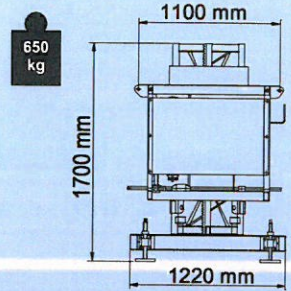

Ruote pivotanti rimovibili Removable pivoting wheels

